

NOTE:
DIMENSION IN PARETHESIS ARE METRIC

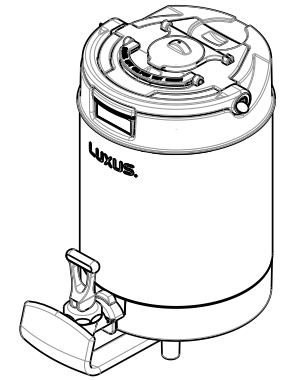

SCALE 0.125

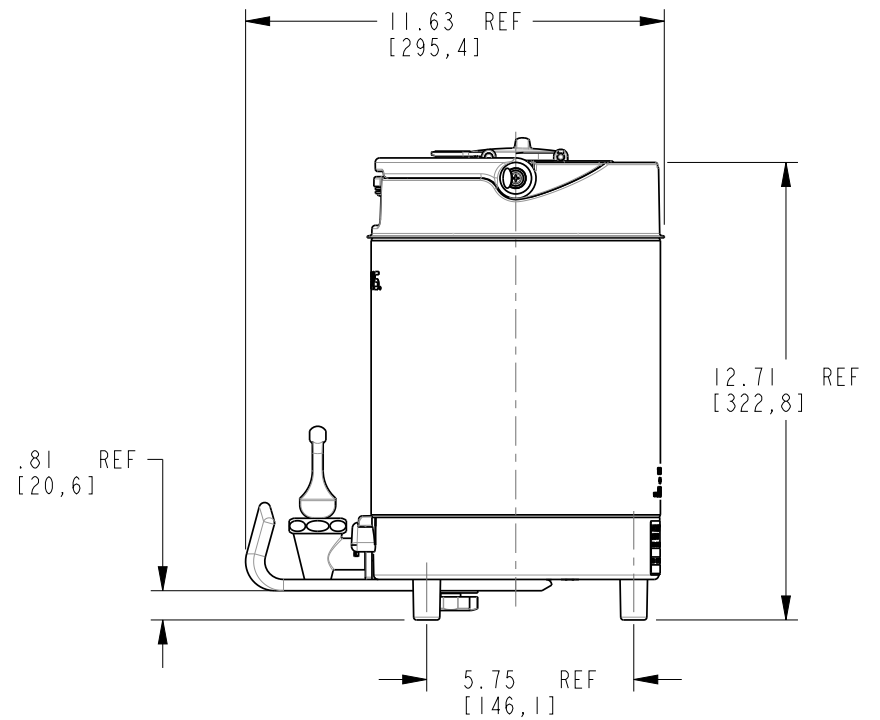
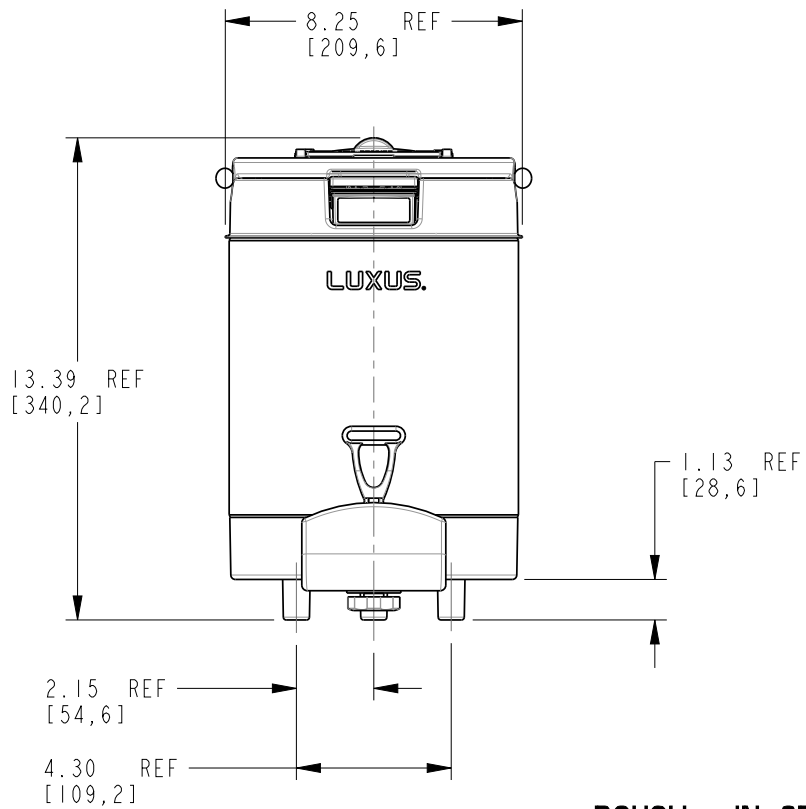

ROUGH - IN SPECIFICATION, L4S-10
FETCO P/N: 1201.00029.00
 (SCALE: .188)

(REF. ASS'Y.: 1101.00323.00)